

# Battery Status Processor BSP

---

## User Manual



# BATTERY STATUS PROCESSOR BSP: USER MANUAL

V 1.2.1

Copyright © 2015 Studer Innotec SA

## ABOUT THE SOFTWARE

This document applies to software versions V1.5.6 or higher of the BSP. It is possible to check the currently used software version with the menu "Information on the system" or to update the product with the latest software version available on "[www.studer-innotec.com/support](http://www.studer-innotec.com/support)".

## LEGAL NOTICE

The use of Studer Innotec SA devices is the responsibility of the customer in all cases. Studer Innotec SA reserves the right to make any modification to the product without prior notice.

## PRODUCT RECYCLING

The BSP conforms to the European directive 2011/65/EU on hazardous substances and does not contain the following elements: lead, cadmium, mercury, hexavalent chrome, PBB or PBDE.

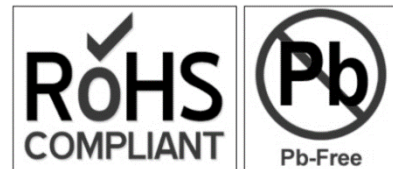

To dispose of this product, please use the service for collection of electrical waste and observe all applicable obligations according to the place of purchase.

# TABLE OF CONTENTS

<b>1</b>	<b>INTRODUCTION.....</b>	<b>5</b>
1.1	General battery knowledge .....	5
1.1.1	Definition of battery capacity .....	5
1.1.2	Capacity and temperature .....	5
1.1.3	Capacity and cell imbalance.....	6
1.1.4	Capacity and discharge current.....	6
1.1.5	Capacity and battery lifetime .....	6
1.2	Conventions .....	6
1.2.1	Symbols .....	6
1.2.2	Parameters .....	6
1.3	Warranty and liability.....	7
1.3.1	Disclaimer of warranty .....	7
1.3.2	Disclaimer of liability .....	7
1.4	Safety precautions .....	7
1.4.1	Generalities .....	7
1.4.2	Warnings .....	8
1.4.3	Safety precautions working with batteries.....	8
<b>2</b>	<b>EC DECLARATION OF CONFORMITY .....</b>	<b>9</b>
<b>3</b>	<b>INSTALLATION .....</b>	<b>10</b>
3.1	Mounting.....	10
3.2	Shunt mounting.....	11
3.3	Cabling.....	11
3.4	Connecting the communication bus.....	11
<b>4</b>	<b>QUICK START GUIDE .....</b>	<b>13</b>
4.1	Choosing the battery capacity.....	13
4.2	Choosing the shunt .....	13
4.3	Reset the battery history to zero .....	14
<b>5</b>	<b>DISPLAY OF THE STATE OF THE BATTERY .....</b>	<b>14</b>
5.1	Graph of the state of charge history.....	14
5.2	Values to display .....	14
<b>6</b>	<b>SETTING OF THE PARAMETERS.....</b>	<b>16</b>
6.1	Generalities.....	16
6.2	Levels of use and of accessibility .....	16
6.3	Basic settings {6000} .....	16
6.3.1	Voltage of the system {6057} .....	16
6.3.2	Nominal capacity {6001}.....	16
6.3.3	Nominal discharge time (C-rating) {6002} .....	16
6.3.4	Nominal shunt current {6017}.....	16
6.3.5	Nominal shunt voltage {6018}.....	16
6.3.6	Reset of battery history {6003} .....	17
6.3.7	Restore default settings {6004}.....	17
6.3.8	Restore factory settings {6005}.....	17
6.4	Advanced settings {6016}.....	17
6.4.1	Reset of user counters {6031}.....	17
6.4.2	Manufacturer SOC for 0 % displayed {6055}.....	17
6.4.3	Manufacturer SOC for 100 % displayed {6056} .....	17
6.4.4	Activate the end of charge synchronization {6042} .....	17

6.4.5	End of charge voltage level {6024} .....	18
6.4.6	End of charge current level {6025} .....	18
6.4.7	Minimum time before end of charge {6026} .....	18
6.4.8	Temperature correction of the end of charge voltage {6048}.....	18
6.4.9	Activate the state of charge correction by the open circuit voltage {6044}.....	18
6.4.10	Battery current limitation activated {6058} .....	18
6.4.11	Max battery charge current {6059} .....	18
6.4.12	Self-discharge rate {6019}.....	18
6.4.13	Nominal temperature {6020} .....	18
6.4.14	Temperature coefficient {6021}.....	19
6.4.15	Charge efficiency factor {6022}.....	19
6.4.16	Peukert's exponent {6023} .....	19
6.4.17	Use C20 capacity as reference value {6049} .....	19
6.5	Configuration as simple counter .....	19
<b>7</b>	<b>FACTORY SETTING VALUES .....</b>	<b>20</b>
<b>8</b>	<b>INDEX OF THE PARAMETERS {XXXX} .....</b>	<b>20</b>
<b>9</b>	<b>BSP SPECIFICATIONS .....</b>	<b>21</b>
9.1	Technical data.....	21
9.2	Readout resolutions .....	21
9.3	Dimensions .....	22
9.4	Mounting.....	23

# 1 INTRODUCTION

The BSP (Battery Status Processor) is designed to monitor lead-acid batteries when used together with inverter-chargers from the Xtender series. An advanced algorithm provides the BSP with the battery's state of charge in real time in order to optimize its use.

The BSP offers voltage measurement for 12, 24 and 48 V batteries as well as current measurement with a resistive shunt. By using the Xtender communication bus, the BSP is able to communicate with the other devices in the system. It is possible to configure the BSP and to display its values with the remote control RCC-02/-03.

Moreover, the Xtender inverter/chargers have the ability to adapt their functioning according to the data given by the BSP.

## 1.1 GENERAL BATTERY KNOWLEDGE

Lead-acid batteries constitute energy storage with complex behaviour. They consist of a collection of 2 Volt (V) cells connected in series to obtain a specific voltage. Depending on the conditions, lead-acid batteries exhibit behaviour far more complicated than a tank that simply fills and empties, due to different physical and chemical phenomena. For this reason it is more difficult to precisely determine a battery's state of charge than, for instance, that of a petrol gauge.

The different values that affect a battery are described below.

### 1.1.1 Definition of battery capacity

A battery's capacity is defined as the amount of electrical charge that a full battery can supply at given current before reaching a certain voltage. Normally the unit Ampere-hour (Ah) is used for its measurement. An ideal 100 Ah battery should for instance supply 10 Amperes (A) during 10 hours or 1 A during 100 hours.

The capacity is usually given at 20 °C for a new battery, with a discharge until 1.8 V per cell (10.8 V for 12 V nominal, 21.6 for 24 V and 43.2 V for 48 V). The time of discharge is indicated by the letter C followed by the duration in hours, for example C10 for a discharge in 10 hours.

To reach a battery's stated capacity, manufacturers charge their batteries according to standard procedures (for instance as per the norm IEC-60896-11). This kind of charge can last up to many tens of hours at very high voltages, which is rather far from normal conditions of use. This is why the real available capacity is often lower than what is stated by the manufacturer. The parameters {5055} and {5056} allow the BSP to measure a state of charge corresponding to the real available capacity.

### 1.1.2 Capacity and temperature

A battery's capacity varies according to the temperature of its active substance. A decrease of temperature diminishes the capacity and an increase of temperature improves the capacity.

### 1.1.3 Capacity and cell imbalance

Despite the fact that it's always the same current that goes through the 2 V cells of a battery, factory differences, even small, might make their state of charge uneven. In case of imbalance, the most discharged cell determines the end of discharge.

Therefore, the cells in series must always be of the same model and have the same history of use. One of the objectives of the absorption and equalization steps is to even out the charge of the cells in series.

### 1.1.4 Capacity and discharge current

The capacity goes down when it comes to big discharge currents. The active substance in the battery needs time to spread into the cells and a quick discharge will lead to a capacity decrease.

To convert the capacity from a discharge duration to another, one can use Peukert's formula.

$$C = C_{ref} \cdot \left( \frac{I}{I_{ref}} \right)^{n_{peukert}^{-1}}$$

The exponent  $n_{peukert}$  varies in every battery and is on average approximately 1.25.  $C_{ref}$  and  $I_{ref}$  refer to the given capacity at a known current.

Discharge speed	Capacity at C10 (100 Ah at 10 A during 10 hours)
C3	0.74
C20	1.19
C50	1.50
C100	1.78



*Capacity ratio with a Peukert exponent of 1.25*

### 1.1.5 Capacity and battery lifetime

The capacity decreases along the charge-discharge cycles. The deep discharges have a particularly negative impact. High ambient temperatures lower also the lifetime.

## 1.2 CONVENTIONS

### 1.2.1 Symbols

	This symbol is used to indicate the presence of a dangerous voltage that is sufficient to constitute a risk of electric shock.
	This symbol is used to indicate a risk of material damage.
	This symbol is used to indicate information that is important or which serves to optimize your system.

### 1.2.2 Parameters

All values mentioned hereafter, followed by a parameter number indicate that this value may be modified using the RCC-02/-03 remote control. In general, the default values are not mentioned and are replaced by a parameter number in the following format: {xxxx}. The default values for these parameters are specified in the defaults parameter table chapter 7: "Factory setting values" (p. 20).

## 1.3 WARRANTY AND LIABILITY

During production and assembling, each BSP gets several controls and tests. They are carried out in full respect of fixed procedures. Each BSP is given a serial number allowing a perfect follow-up of the controls, in conformity with the specific data of every device. For this reason, it is very important to never remove the descriptive sticker bearing the serial number. The production, the assembling and the tests of each BSP are entirely carried out in our factory in Sion (CH). The warranty of this product depends on strictly following the instructions in this manual. The warranty period for the BSP is 5 years.

### 1.3.1 Disclaimer of warranty

No warranty will be applied for damages caused by handling, operation or actions that are not described in this manual. Damages arisen from the following events are not covered by the warranty:

- Overvoltage on the device (Applying a voltage higher than 85 Vdc).
- Reverse polarity while connecting the battery.
- Liquid in the device or oxidation due to condensation.
- Failures due to a fall or to a mechanical shock.
- Modifications made without the explicit authorization of Studer Innotec SA.
- Nuts or screws partially or insufficiently tight during installation or maintenance.
- Damages due to atmospheric overvoltage (lightning).
- Damages due to transport or improper packaging.
- Disappearing of original marking items.

### 1.3.2 Disclaimer of liability

Installation, commissioning, use and maintenance of this device cannot be supervised by the company Studer Innotec SA. For this reason, we do not accept any liability for damages, costs or losses generated either by an installation that is not conforming to the prescriptions, by a defective operation or by poor maintenance. The use of this device is under the responsibility of the end-user. This device is neither designed nor guaranteed for the supply of life support applications or any other critical application with potential risks for human beings or for the environment. We shall assume no liability for patent infringement or other third party rights involved in the use of this device.

## 1.4 SAFETY PRECAUTIONS

### 1.4.1 Generalities

Do read carefully all safety instructions before proceeding to the installation and commissioning of the device. Not respecting these instructions might constitute a lethal physical danger but can also damage the functionalities of the device. Therefore, do keep this manual close to the device.



Strictly follow the local and national norms and regulations in force. This is valid for all installations.

## 1.4.2 Warnings



- This device is used together with a permanent energy source (battery bank) and can also receive an alternative source at its input. Before any handling it is then necessary to disconnect all energy sources from the device.
- Never use this device in a place where explosions might occur. Do refer to the indications of the battery manufacturer to ensure of the compatibility of the battery with the device. The safety instructions of the battery manufacturer have to be followed strictly too!
- Wherever the installation, the person in charge of installation and commissioning must know perfectly the safety measures and the prescriptions in force in the country. Therefore, the whole maintenance must be carried out by a qualified staff.
- All components connected to this device must be conforming to the laws and regulations in force. The persons without a written authorization from Studer Innotec SA are forbidden to do any change, modification or repair whatsoever. Regarding authorized modifications and replacements, only genuine components shall be used.
- This device is meant for a use only indoor and must under no circumstances stand in the rain, the snow or any other humid or dusty environment.
- In case of use in motor vehicles this device must also be protected against vibrations by absorbing components.

## 1.4.3 Safety precautions working with batteries

Lead acid batteries with liquid electrolyte produce a highly explosive gas during normal operation. No source of spark or of fire should be present in the closeness of the batteries. The batteries must be installed in a well-ventilated space and mounted so as to avoid accidental short circuits while connecting them.



During any work on batteries, a second person must be present in case a problem occurs that requires assistance. There should be within reach enough fresh water and soap for an immediate washing of the skin or the eyes in case of accidental contact with acid. Should it happen, they must be washed carefully during at least 15 minutes with cold water. It is then necessary to immediately consult a doctor.



## 2 EC DECLARATION OF CONFORMITY

The Battery Status Processor (BSP) described in this manual meets the requirements specified in the following EC directives and norms:

- Low voltage directive 2006/95/EC: EN 60950:2005
- EMC directive 2004/108/EC: EN61000-6-1:2005 and EN61000-6-3:2006
- RoHS directive 2011/65/EU



CH - 1950 Sion, January 2016

Studer Innotec SA (R. Studer)

A handwritten signature in black ink, appearing to read "R. Studer". The signature is fluid and cursive, written over a white background.

### **Studer Innotec SA contact details**

Studer Innotec SA  
Rue des Casernes 57  
CH - 1950 Sion  
Switzerland

+41 (0) 27 205 60 80  
+41 (0) 27 205 60 88

info@studer-innotec.com  
www.studer-innotec.com

### 3 INSTALLATION

The BSP must be mounted as close as possible to the battery. In this way, the measurement perturbations are minimized and the temperature sensor integrated in the box gives a more accurate measure of the battery temperature. It is not advisable to lengthen the wires (d), (c) and (b). If absolutely necessary, the two wires (b) need to be lengthened separately in order to guarantee a correct measuring of the current.

If the BSP has to be installed in another room, it is possible to use the temperature sensor BTS that will be connected to the Xtender. In that case the temperature of the BTS will be automatically taken into account for the state of charge calculation.

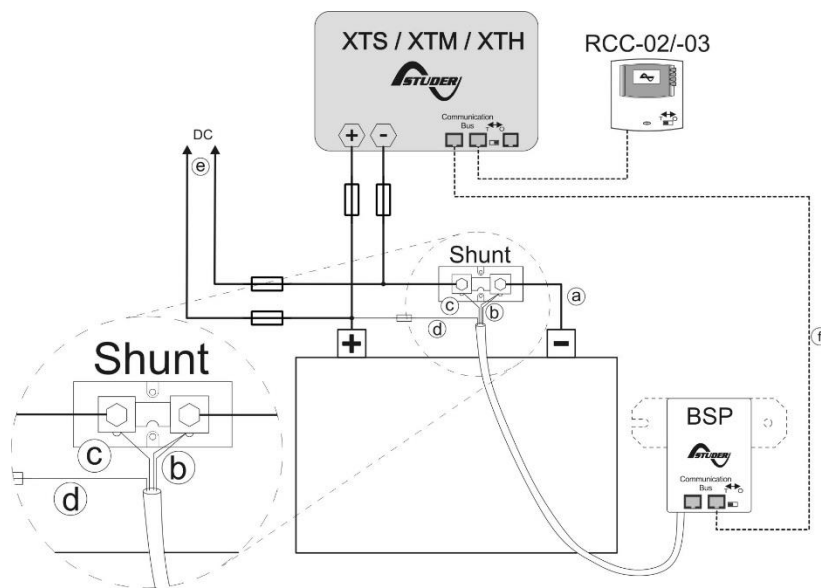

Figure 3.1: Connecting schematic of the BSP

#### 3.1 MOUNTING

Ideally, the BSP can be stuck directly to the battery. It can also be mounted close to the battery by means of the fixing plate supplied with (see figure 3.2 (p. 12)).

The direct mounting on the battery offers a more precise measurement of the battery temperature. While changing the battery bank, the BSP will have to be stuck again with a new double-side adhesive.

	The BSP must be mounted to avoid any contact with acid from the battery. It should be taken care of fixing it vertically with the communication bus connectors downwards.
--	---

### 3.2 SHUNT MOUNTING

The shunt supplied with the device allows the measurement of the battery current. It must imperatively be installed in series with the negative terminal of the battery. The connection (a) of the figure 3.1 must be as short as possible. For a good operating of the charge estimating algorithm, all the current must go through the shunt. No other conductive component shall be connected to the negative terminal of the battery.



The shunt must be exclusively mounted on the negative terminal of the battery.

### 3.3 CABLING

The cabling schematic is available on figure 3.1. The cabling procedure is as follows:

1. Connect the shunt to the negative terminal of the battery (a). (Tightening torque: 20 Nm for the BSP500, 45 Nm for the BSP1200).



Beware of the cable cross section! All current (Xtender + solar module(s) or consumer(s) directly connected to the DC side) will go through this cable for the charge and discharge of the battery.

2. Connect the black and yellow wires of the BSP cable to the screw of the shunt on battery side (b).
3. Connect the blue wire of the BSP to the second screw of the shunt (c).
4. Connect the red wire with a fuse to the positive terminal of the battery (d).



It might happen while connecting the red wire to the battery that a spark is generated. No damage is likely to happen or to damage the device.

5. Connect the negative cables of the inverter, the solar regulator and/or DC consumers to the free bolt of the shunt. The positive cables are being connected straight to the positive terminal of the battery (e).

6. Connect the communication cable to the communication bus of the Xtender system and activate, if necessary, the link end (f). For more information, see the section 3.4.

### 3.4 CONNECTING THE COMMUNICATION BUS

The devices of the Xtender range are equipped with an owned communication bus for data exchange, configuration and updating of the system. Connection is being made by linking the devices with the communication cables. One gets then a bus online where a link end must be activated on the devices on each end, to obtain the configuration of the figure 3.2

Each device is equipped with a switch offering to choose between open "O" and terminated "T". The devices at the end of the line must be set on "T" and all the others on "O".



An incorrect setting of the link ends can lead to an erratic running of the installation or impede its updating.

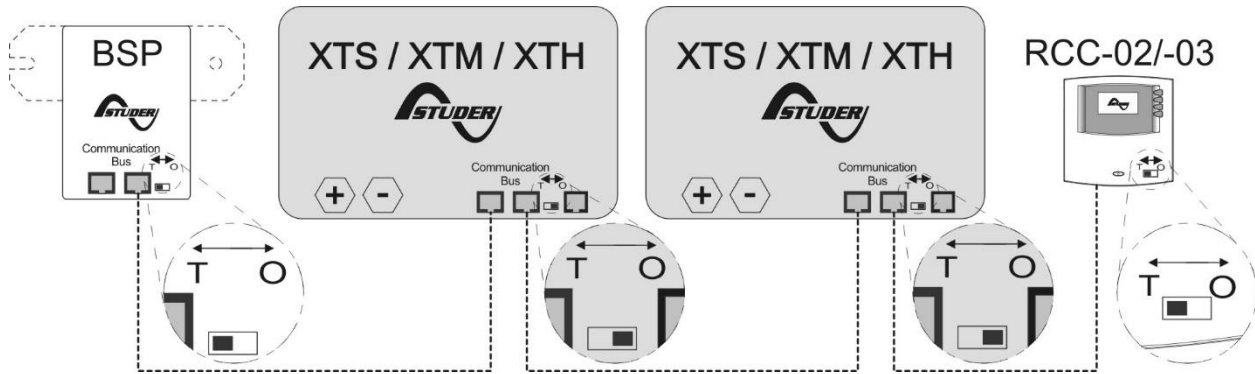

Figure 3.2: Communication bus online of the Xtender system

	<p>When the BSP is connected with the communication bus to other devices (Xtender, VarioTrack, RCC, Xcom or other) the software versions may not be compatible. . It is highly recommended to make a software update of all components in the system in order to guarantee all functionalities. Therefore, before starting the setup of the device, download the latest software version from our website: <a href="http://www.studer-innotec.com">www.studer-innotec.com</a> on an SD card. Follow the instructions in the RCC manual for a successful installation.</p>
--	---

## 4 QUICK START GUIDE

You will find in this chapter the procedure to follow in order to configure the BSP during installation. For the major part of the systems this is good enough. For a full list of the parameters that can be set, refer to chapter 7.

### 4.1 CHOOSING THE BATTERY CAPACITY

The battery capacity must be configured. The manufacturer gives it at various discharge times (see section 1.1.1). If several capacities at different times are supplied, the discharge time in 20 hours (C20) must be chosen because these are the reference conditions for the state of charge calculation.

From the initial display of the RCC and by means of the keys UP and DOWN, move to the configuration menu of the BSP parameters, then push SET.



To modify the parameter "Battery Capacity" {6001}, move with the arrows UP and DOWN to the general menu.

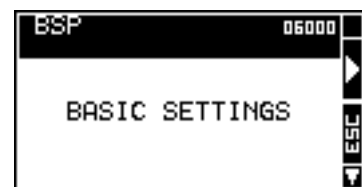

Then push on SET to enter the menu. With the arrow DOWN, move to the parameter "Battery Capacity".

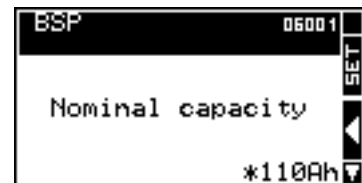

To modify its value push on SET. The value turns in reverse video. Change the value for the one of your battery with the keys UP and DOWN. Confirm by pushing on SET.



Then, configure the parameter "Nominal Discharge Time(C-rating)" {6002} the same way as for the battery capacity.

### 4.2 CHOOSING THE SHUNT

If you are using a shunt supplied with the BSP-500, the BSP is configured for it and you can go directly to the next section.

Otherwise, the measuring shunt must be configured. The shunts are meant to supply a measuring nominal voltage at a nominal current. If you use the shunt supplied with the BSP-1200, the nominal current is 1200A at 50 mV. If you use your own shunt, the current and the nominal voltage are given by the manufacturer and are often printed on the shunt.

The parameters "Nominal Current of the shunt" {6017} and "Nominal Voltage of the shunt" {6018} of the advanced menu enable to configure the BSP for a given shunt.

### 4.3 RESET THE BATTERY HISTORY TO ZERO

If you install the BSP for the first time or if the battery has been changed, you must reset the battery history to zero, by means of the parameter {6003}.

## 5 DISPLAY OF THE STATE OF THE BATTERY

On installations with a BSP, the view over information on the battery is added to the RCC.

In area (A), four values of the BSP are displayed. The symbol of the battery in (B) gives a quick overview of the state of charge (SOC). The direction of the current is given in (C). An arrow upwards means the charge, downwards, the discharge.

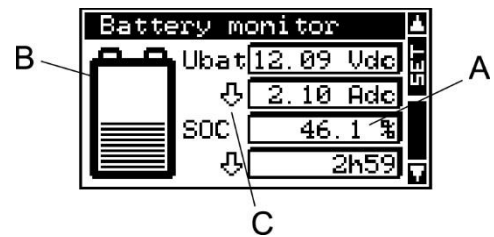

### 5.1 GRAPH OF THE STATE OF CHARGE HISTORY

It is possible to see the battery state of charge of the last 5 days on the RCC. On that purpose, from the view over the battery information, you enter in selection mode with the key SET. The battery is then selected. The key SET allows then to display the graph.

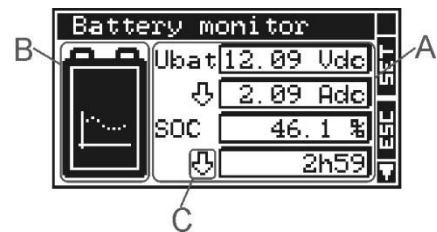

The graph of the state of charge is then displayed. On the horizontal scale are today and the last 4 days. The graduations indicate every hour from midnight to midnight. Each horizontal pixel means one hour. The vertical axis gives the state of charge of the battery. The graduations mean 20, 40, 60, 80 and 100 % and one pixel means 2 %.

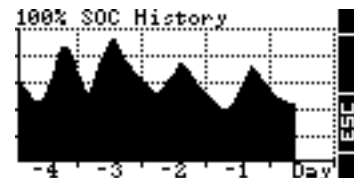

### 5.2 VALUES TO DISPLAY

It is possible to modify the values to display on the battery view. For that, from the basic view of the battery monitor push SET. The battery is then selected and is illustrated in black. Go to the first value displayed with the key DOWN. The keys UP and DOWN allow going to the field to configure. With the key SET, enter the menu corresponding to the value to display.

Then, choose the value to display by means of UP and DOWN and push on SET to validate.

At any time, to quit, use the key ESC that will bring you to the previous view.

The values available are the following:

Name of the value	Unit	Description
Battery voltage	Vdc	-
Battery current	Adc	-
State of Charge	%	State of charge indicated by the battery icon and transmitted to the other devices.
Power	W	-
Time to go	hh:mm	During discharging, it indicates the time before it reaches 0 %. This value is calculated on basis of the present current. What it gives is an indication. A variable energy consumption has of course a big impact on this value. During charging, this value is undetermined.
Battery temperature	°C	Temperature used to calculating the battery state of charge. Unless a BTS is connected to the Xtender and therefore its value taken into account, this is the temperature measured inside the BSP that will be used.
BTS temperature	°C	Temperature of a XT, VT or VS to which the BTS is connected or '---' if not present.
Ah charged today	Ah	Charge supplied to the battery from midnight until now.
Ah discharged today	Ah	Charge supplied by the battery from midnight until now.
Ah charged yesterday	Ah	-
Ah discharged yesterday	Ah	-
Total kAh charged	kAh	Charge supplied to the battery from the last reset to zero of the battery history. See "Reset of battery history {6003}" (p. 17).
Total kAh discharged	kAh	Charge supplied by the battery from the last reset to zero of the battery history.
Total time	Days	Time since the last reset of the battery history.
Charge counting on the user side	Ah	With this value, the user can measure the charge or discharge of the battery according to his needs. This counter, as well as the other two mentioned below in this table, can be reset to zero by means of the parameter "Connecting the communication bus {6031}" (p. 17). Displays '---' above 65504.
Discharge counting on the user side	Ah	Displays '---' above 65504.
Duration of the counting on the user side	Hours	Displays '---' above 65504.
Manufacturer SOC	%	See {6055} and {6056}

## 6 SETTING OF THE PARAMETERS

A complete list of accessible parameters can be found in chapter 7 (p. 20).

### 6.1 GENERALITIES

The configuration is carried out on the remote control RCC-02/-03 by means of the BSP parameter menu. Generally the settings described in chapter 5: "Quick Start guide" (p. 13) are enough for a good operation of the BSP. It is however possible to modify many other parameters described in this chapter.

### 6.2 LEVELS OF USE AND OF ACCESSIBILITY

The functions described below correspond to the level EXPERT. As per the user level selected, the access to all these functions might not be possible. Do refer to the chapter user level setting in the remote control RCC-02/-03 manual for more information about this matter.

### 6.3 BASIC SETTINGS {6000}

The parameters for a basic configuration of the BSP are in this menu.

#### 6.3.1 Voltage of the system {6057}

The BSP has an automatic battery recognition mode. When connected to a battery it will measure the available voltage and detect if it is a 12 V, 24 V or 48V battery. It is possible to force the BSP to function with a given voltage with parameter {6057}. When the battery voltage is known, it may be wise to set the battery voltage (12 V, 24 V or 48 V). This in order to avoid any confusion when connecting a highly discharged battery or while using technology developed for a large voltage range.

#### 6.3.2 Nominal capacity {6001}

Nominal battery capacity. It is indicated for the nominal discharge time defined by the parameter {6002}. For instance 203 Ah.

#### 6.3.3 Nominal discharge time (C-rating) {6002}

Discharge time needed to give the battery nominal capacity of the parameter {6001}. For instance C5/C10/C20/C100.

#### 6.3.4 Nominal shunt current {6017}

This parameter enables to adjust the BSP measurement to the shunt. It must be set according to the nominal voltage of the shunt (parameter {6018}). For instance for the shunt 1200 A supplied with the BSP-1200, the setting will be 1200 A and 50 mV.

#### 6.3.5 Nominal shunt voltage {6018}

See parameter {6017}.



### 6.3.6 Reset of battery history {6003}

This parameter enables to reset to zero all counters of the section 5.2 and the algorithm during installation on a new battery.

	This parameter should normally not be used if the battery has not been changed, because then the history (total current, estimated capacity) is lost.
---	---

### 6.3.7 Restore default settings {6004}

Use this parameter to restore the initial settings of the BSP.

	If your installer has made some settings at "installer" level while commissioning your installation, this function restores his settings and not the factory ones.
---	--

### 6.3.8 Restore factory settings {6005}

With this function, you can find the factory settings. For each parameter, not only the factory value is restored but also the limits and the user level. This function is only accessible with the level installer.

## 6.4 ADVANCED SETTINGS {6016}

Parameters used for advanced configuration of the BSP.

### 6.4.1 Reset of user counters {6031}

This parameter allows to reset to zero the charge, discharge and time user counters of the section 5.2.

### 6.4.2 Manufacturer SOC for 0 % displayed {6055}

### 6.4.3 Manufacturer SOC for 100 % displayed {6056}

The capacity given by the battery manufacturer conforms to a discharge test that is not representative for the recommended conditions of use. These two parameters define the SOC range corresponding to the manufacturer's test giving a display in between 0 and 100%.

For instance, if the maximum discharge rate is set to 30% with the parameter {6055}, the BSP will display a value of 0 % when arriving at this level. The manufacturer's charge rate consists of tens of hours in the absorption phase. If a battery is considered full to 90 % at this charge level, use this value to set parameter {6036}. When arriving at this level the BSP will display 100 %.

The displayed state of charge (SOC) is also the one used by the Xtender to calculate the remaining autonomy and for logged data.

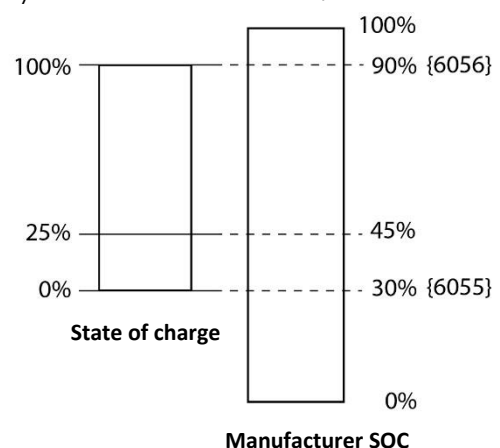

### 6.4.4 Activate the end of charge synchronization {6042}

This parameter activates the function of synchronization at 100 % of SOC under certain conditions of end of charge.

For the synchronization to occur:

- the voltage shall be above parameter {6024}
- the current shall be below parameter {6025}
- and this during a period defined by the parameter {6026}

This function is not compulsory because the BSP adjusts automatically the state of charge as per the voltage.

#### **6.4.5 End of charge voltage level {6024}**

See explanation at parameter {6042}.

#### **6.4.6 End of charge current level {6025}**

See explanation at parameter {6042}.

#### **6.4.7 Minimum time before end of charge {6026}**

See explanation at parameter {6042}.

#### **6.4.8 Temperature correction of the end of charge voltage {6048}**

The voltage set with parameter {6024} can be corrected with this coefficient. By using a reference temperature of 25 °C it is possible to have a similar charge behaviour of the Xtender, the VarioTrack or the VarioString.

#### **6.4.9 Activate the state of charge correction by the open circuit voltage {6044}**

When this parameter is activated, the state of charge is corrected by the battery voltage. This function is only effective for lead-acid batteries.

#### **6.4.10 Battery current limitation activated {6058}**

#### **6.4.11 Max battery charge current {6059}**

The activation of the parameter {6058} allows to implement a global limit on the battery charge current equal to the value of the parameter {6059} given the current measured by the BSP. This limitation is imposed on VarioTracks and VarioStrings with software versions equal or greater than 1.5.30 and 1.5.20, respectively. Nonetheless, the limit does not affect the charge current of the Xtenders.

#### **6.4.12 Self-discharge rate {6019}**

A battery gets discharged over time even when no current is consumed. This parameter allows to take this phenomenon into account.

#### **6.4.13 Nominal temperature {6020}**

The battery parameters are specified for a given temperature by their manufacturer. This parameter makes it possible to modify that temperature.

#### 6.4.14 Temperature coefficient {6021}

The available capacity diminishes with the decrease of the temperature. This coefficient enables to take this factor into account.

#### 6.4.15 Charge efficiency factor {6022}

During charging, less Ah are stored into the battery than during discharging. The ratio discharge/charge can be set with this parameter.

#### 6.4.16 Peukert's exponent {6023}

The capacity varies according to the discharge current (see section 1.1.4). With this parameter, one can set the Peukert exponent that goes along with the nominal capacity {6001} and nominal discharge time.

#### 6.4.17 Use C20 capacity as reference value {6049}

The calculation of the SOC algorithm is based on the capacity achieved during a 20h discharge (C20) which is set using parameters {6001}, {6002} and {6023}. When this parameter is set to "no", the capacity of parameter {6001} is used.

### 6.5 CONFIGURATION AS SIMPLE COUNTER

When using other battery technologies than lead it is necessary to configure the BSP as a simple counter without correction. It is necessary to activate the "end of charge synchronisation" to avoid the state of charge to derive due to measuring errors and loss of battery capacity. The parameters can be modified as follows:

Level	User ref.	Parameter	Factory value	Unit
Expert	6055	Manufacturer SOC for 0 % displayed	0	%
Expert	6056	Manufacturer SOC for 100 % displayed	100	%
Expert	6042	Activate the end of charge synchronization	Yes	-
Expert	6024	End of charge voltage level	Values to be chosen depending on technology	V
Expert	6025	End of charge current level		%cap
Expert	6026	Minimum duration before end of charge		s
Expert	6048	Temperature correction of the end of charge voltage	0	mV/°C/cell.
Expert	6044	Activate the state of charge correction by the open circuit voltage	No	-
Expert	6019	Self-discharge rate	0	%/months
Expert	6021	Temperature coefficient	0	%cap/°C
Expert	6022	Charge efficiency factor	100	%
Expert	6023	Peukert's exponent	1.0	
Expert	6049	Use C20 Capacity as reference value	No	

## 7 FACTORY SETTING VALUES

Level	User ref.	Parameter	Factory value	User value
Basic	6001	Nominal capacity	110 Ah	
Basic	6002	Nominal discharge duration (C-rating)	20 h	
Expert	6003	Reset of battery history	-	
Basic	6004	Restore default settings	-	
Inst.	6005	Restore factory settings	-	
Basic	6017	Nominal shunt current	500 A	
Basic	6018	Nominal shunt voltage	50 mV	
Expert	6058	Battery current limitation activated	No	
Expert	6019	Self-discharge rate	3 %/month	
Expert	6020	Nominal temperature	20 °C	
Expert	6021	Temperature coefficient	0.5 %cap/°C	
Expert	6022	Charge efficiency factor	90%	
Expert	6023	Peukert's exponent	1.2	
Expert	6024	End of charge voltage level	13.2/26.4/52.8 V	
Expert	6025	End of charge current level	2 %cap	
Expert	6026	Minimum duration before end of charge	240 s	
Expert	6031	Reset of user counters	-	
Expert	6042	Activate the end of charge synchronization	No	
Expert	6044	Activate the state of charge correction by the open circuit voltage	Yes	
Expert	6048	Temperature correction of the end of charge voltage	0 mV/°C/cell	
Expert	6049	Use C20 Capacity as reference value	Yes	
Expert	6055	Manufacturer SOC for 0 % displayed	30%	
Expert	6056	Manufacturer SOC for 100 % displayed	100%	
Basic	6057	Voltage of the system	Automatic	

## 8 INDEX OF THE PARAMETERS {XXXX}

{5055}.....	5	{6023}.....	19
{5056}.....	5	{6024}.....	18
<b>{6000}</b> .....	16	{6025}.....	18
{6001}.....	13, 16, 19	{6026}.....	18
{6002}.....	13, 16, 19	{6031}.....	15, 17
{6003}.....	14, 15, 17	{6036}.....	17
{6004}.....	17	{6042}.....	17, 18
{6005}.....	17	{6048}.....	18
{6016}.....	17	{6049}.....	19
{6017}.....	14, 16	{6055}.....	15, 17
{6018}.....	14, 16	{6056}.....	15, 17
{6019}.....	18	{6057}.....	16
{6020}.....	18	{6058}.....	18
{6021}.....	19	{6059}.....	18
{6022}.....	19		

## 9 BSP SPECIFICATIONS

### 9.1 TECHNICAL DATA

<b>Supply voltage range</b>	7...85 Vdc
<b>Supply current</b>	9 mA @ 12 V
	5 mA @ 24 V
	3 mA @ 48 V
<b>Input voltage range</b>	7...85 Vdc
<b>Shunt measurement input range</b>	±195 mV
<b>RMS continuous current @ 25 °C</b>	±500 A (BSP 500)
	±1200 A (BSP 1200)
<b>Maximum measurable peak current</b>	±1950 A (BSP 500)
	±4680 A (BSP 1200)
<b>Voltage measurement accuracy</b>	0.3 %
<b>Current measurement accuracy</b>	0.5 %
<b>Battery capacity</b>	20...20000 Ah
<b>Operating temperature range</b>	-20...55 °C
<b>Packed weight</b>	900 g (BSP 500)
	1500 g (BSP 1200)
<b>Displayable values</b>	see table 6.1
<b>Protection degree</b>	IP20
<b>Conformity</b>	LVD 2006/95/EC, EMC 2004/108/EC, RoHS 2011/65/EU, EN 60950:2005, EN 61000-6-2:2005, EN 61000-6-3:2007

### 9.2 READOUT RESOLUTIONS

<b>Voltage</b>	±0.01 V
<b>Current (A) and capacity (Ah)</b>	±0.01 (1...10)
	±0.1 (10...100)
	±1 (100...999)
	±10 (1000...9999)
	±100 (10000...65000)
<b>State of charge</b>	±0.1 %
<b>Temperature</b>	±0.1 °C
<b>Time to go</b>	±1'

### 9.3 DIMENSIONS

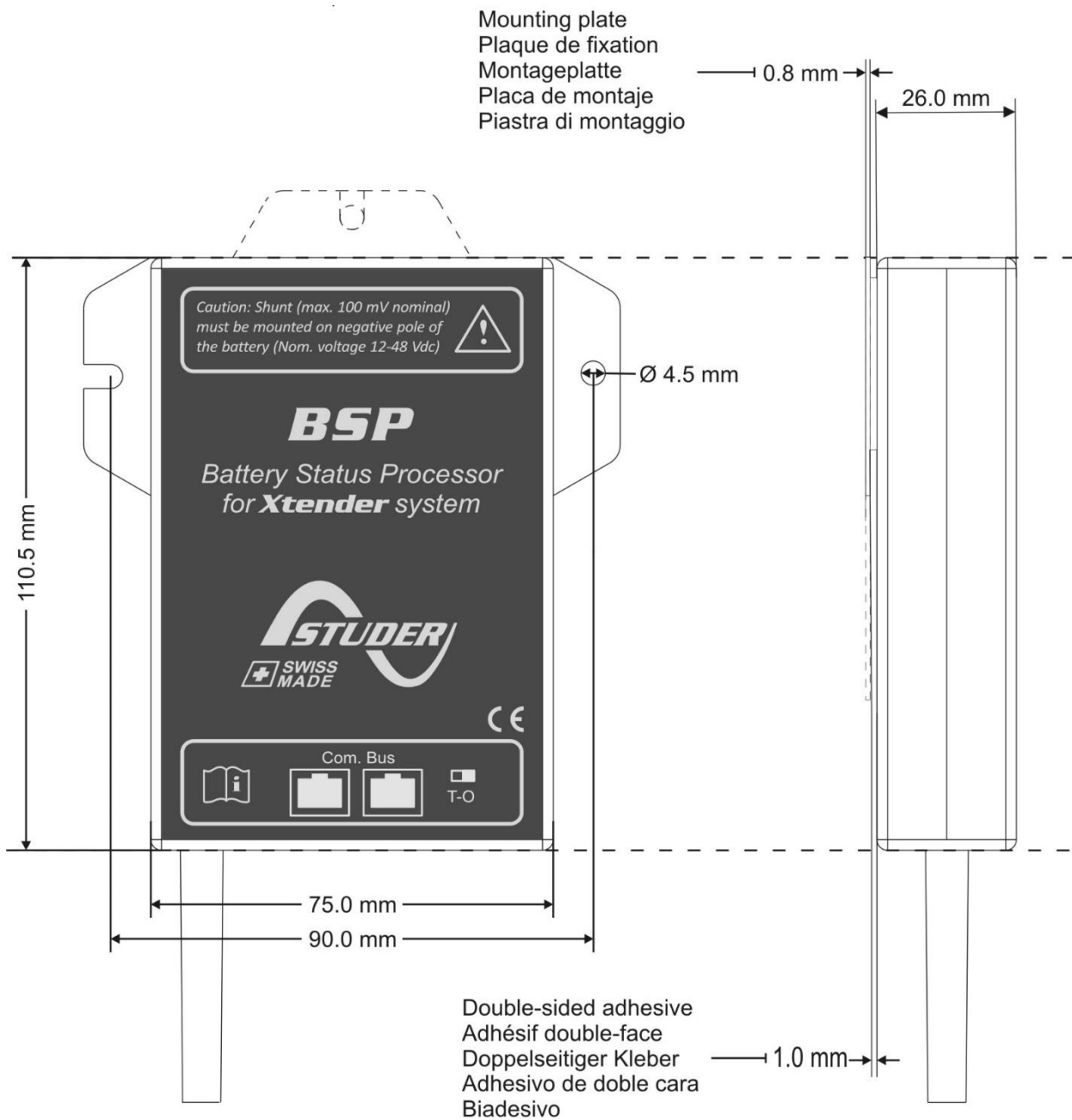

## 9.4 MOUNTING

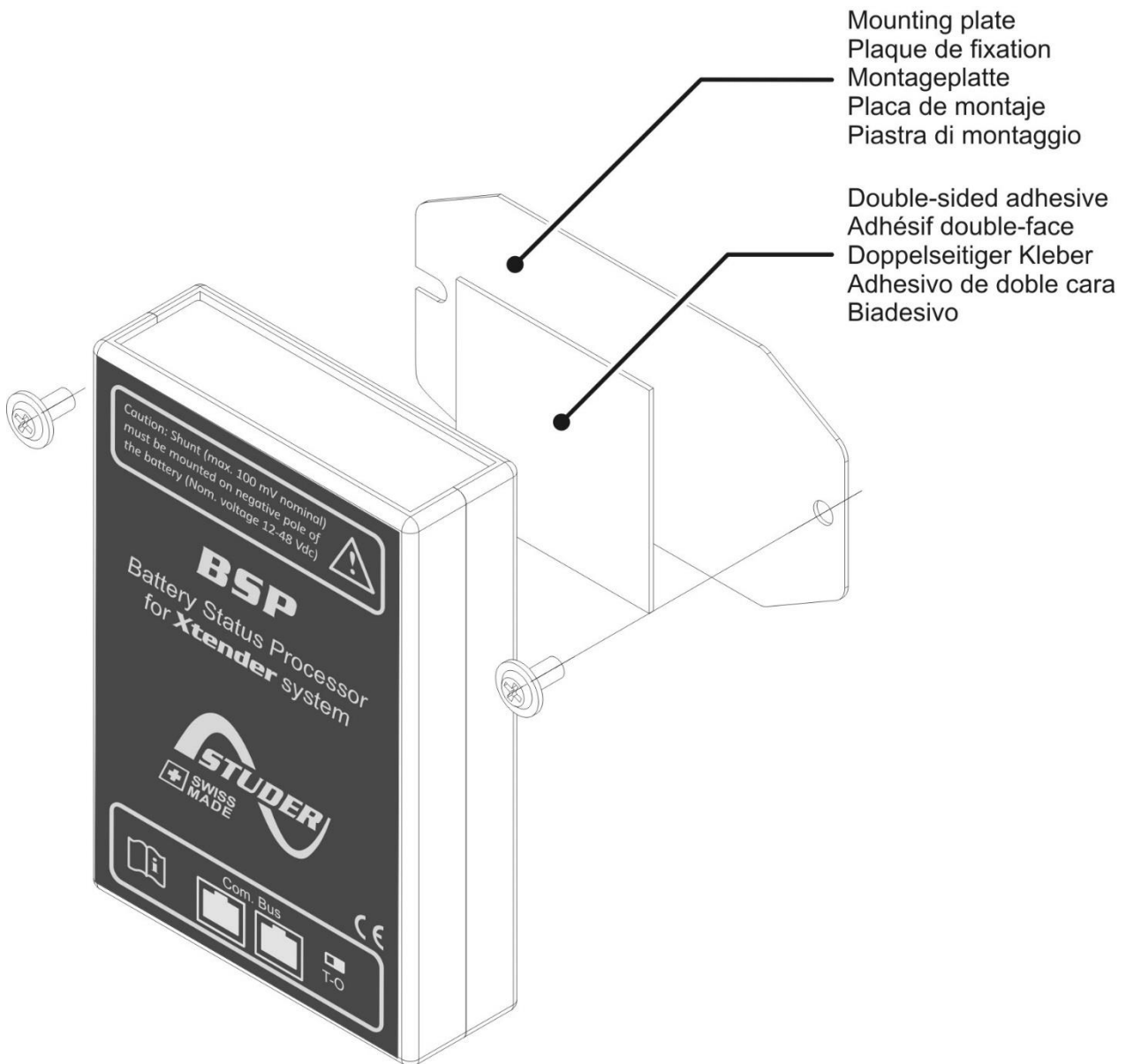



Studer Innotec SA  
Rue des Casernes 57  
CH -1950 Sion, Switzerland  
+41 (0) 27 205 60 80  
+41 (0) 27 205 60 88

[info@studer-innotec.com](mailto:info@studer-innotec.com)  
[www.studer-innotec.com](http://www.studer-innotec.com)