



Optimal solar backup

General description

This application note describes how to use renewable energy in a backup system, even when the system is connected to a grid and grid feeding is not possible.

Features & advantages

- Ideal for backup systems with renewable energy where there is no feed-in tariff or where grid feeding is not possible.
- Use all of the available renewable energy.
- Direct use of renewable energy without cycling energy in the battery(-ies) to avoid their premature aging.

Minimal configuration

- Range of inverters
 - All Xtender Series
- Xtender
 - Software vers. : 1.3.28 and higher
- RCC-02/-03
 - Software vers. : 1.3.32 and higher
 - RCC User level : EXPERT

Attention! This function cannot be used with two or three Xtenders connected in parallel. The 3-phase system is allowed but only with one unit per phase.

Application Schematic

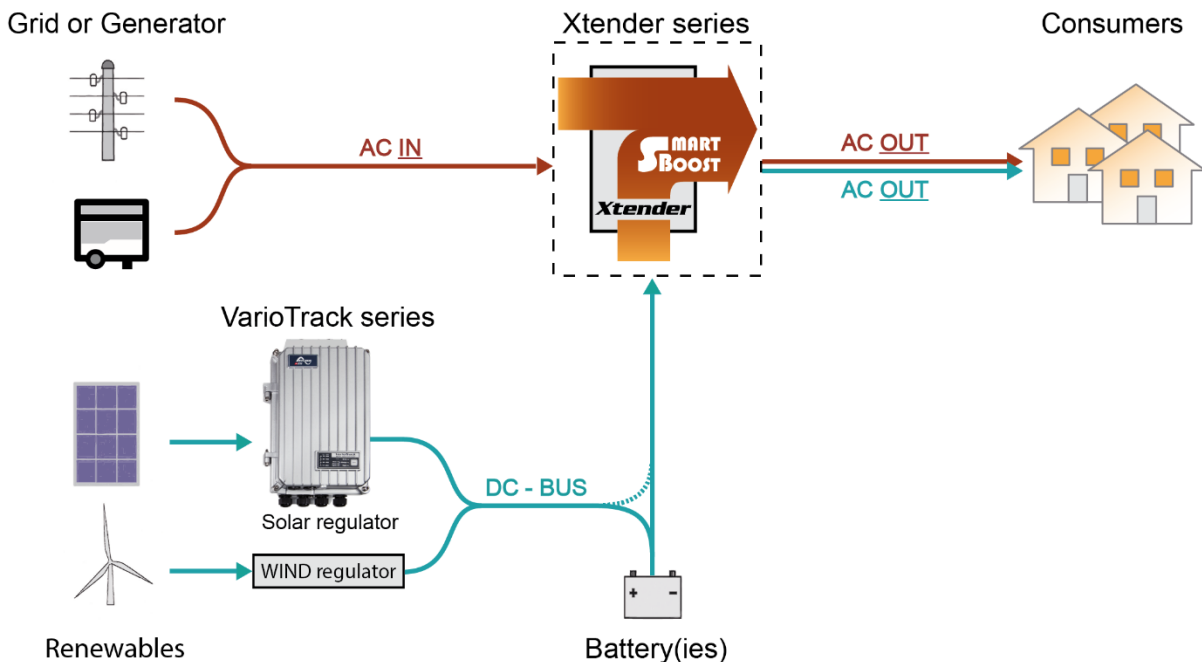

(Figure 1) Backup system using renewable energy without grid feeding

Detailed description

Operation description

In a backup system, the power to the end consumer is taken from the input (grid, generator...) or, in a blackout situation, from the DC side (battery(-ies), renewables).

Generally, **in the case where grid feeding is not possible**, the renewable energy is lost when the system is powered from input.

This application note shows the possibility to use the renewable energy of the system even when the system is connected to a grid.

This operation requires an inverter-charger from the Xtender series with two special functions.

- The Smart-Boostⁱ function which adds power to the AC source according to the input limit current.
- The solar priority function which adjusts the instantaneous power consumed from the source according to the battery(-ies) voltage.

The operation of the solar priority function is done with an automatic modification of the input limit current. The input limit current is decreased from the initial value (given by the user) if there is enough energy available at the DC side. The lower the input current, the more the load is provided with DC power by the Smart-Boost function. In this way, the power from the DC side is integrated in the system and the input consumption is limited.

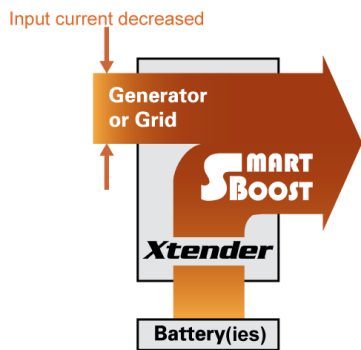

(Figure 2) Smart-Boost function

Battery priority voltage, description and dimensioning

The point where the input limit starts to decrease is the priority voltage of the battery(-ies), parameter {1297}ⁱⁱ.

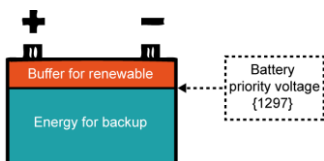

(Figure 3) Battery priority voltage

This parameter sets two zones in a battery(-ies):

- A zone below this point, which ensure an energy reserve for a blackout situation.
- A zone above this point where the renewable energy in excess can be stored.

When there is higher production of renewables than power consumed, it is possible to store this production in the battery(-ies)'s buffer zone for later use (see figure 4).

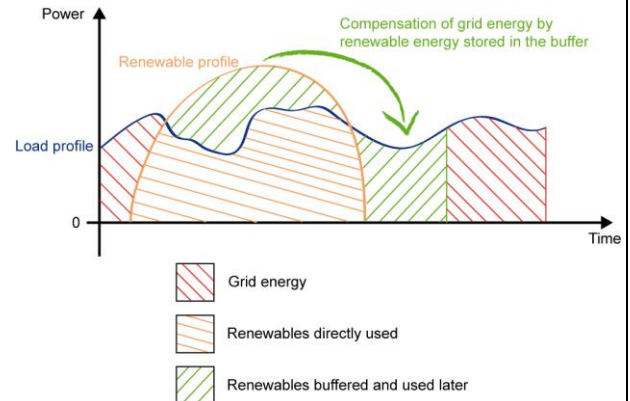

(Figure 4) Load profile with renewable energy buffered

An example to determine the value of the battery(-ies) priority voltage considering a battery(-ies) of 24Vdc (Full battery(-ies) = 25.5Vdc, empty battery(-ies) = 24Vdc) and a backup zone of 80% of the total capacity of the battery(-ies) :

$$\begin{aligned}
 \text{-Full battery(-ies) (Full}_{bat}\text{)} &= 25.5\text{Vdc} \\
 \text{-Empty battery(-ies) (Empty}_{bat}\text{)} &= 24.0\text{Vdc} \\
 \text{Battery(ies) priority voltage is :} \\
 \text{Empty}_{bat} + 80\% * (\text{Full}_{bat} - \text{Empty}_{bat}) \\
 &= 24 + 0.8 * (25.5 - 24) = \mathbf{25.2\text{Vdc}}
 \end{aligned}$$

Note that even with the battery priority voltage, the battery charging proceeds normally and accepts the absorption and equalization phases. Thus, it is possible to program absorption and equalization phases to reduce the problem of stratification of the acid and the water decrease in the batteries.

But to avoid cycling the batteries too often, it is necessary to adjust the parameter {1297} (Battery priority voltage) to a value higher than the parameter {1143} (Battery voltage level 1 to start a new cycle).

Saving the renewable energy or the battery(-ies) life?

In such a system, there is the choice between storing or not the renewables in excess.

If renewable energy is stored, energy in the battery(-ies) will therefore be cycled, implying a decrease of the battery(-ies) lifetime.

If renewable energy is not stored, it will be lost but the energy in the battery(-ies) will be stable, implying an extension of the battery(-ies) lifetime.

The question is whether to store the excess renewable energy not?

Where the price of battery(-ies) storage is cheaper than the cost of grid/generator energy, it is advisable to store the renewables in excess.

Otherwise, if grid/generator energy is cheap, it is advisable not to store the renewables in excess.

If the renewable energy production in excess is not buffered (Figure 5), the battery(-ies) priority voltage should be set, for example, to 0.5Vdc below the floating voltage of the solar/wind regulator.

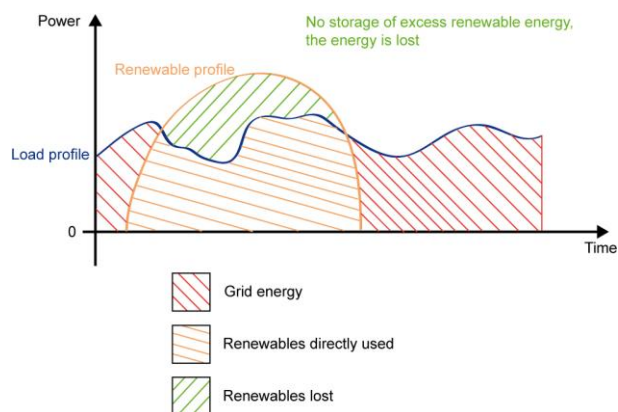

(Figure 5) Load profile without renewable energy buffered

Another case concerns the situation where there is no excess renewable energy (Figure 6).

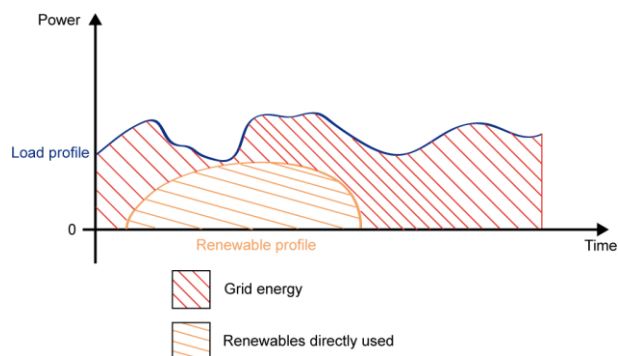

(Figure 6) Load profile without excess of renewables

The battery(-ies) priority voltage should also be set to 0.5Vdc below the floating voltage of the solar/wind regulator to keep it loaded to a maximum.

Operating example

For example, if battery(-ies) are higher than the priority voltage and if a solar panel is connected to the battery(-ies) at the DC side, its regulator (MPPT or other) provides solar power to the DC-bus. At the same time, the Xtender will take away the solar power to maintain the DC-Bus at the priority voltage. This represents a direct use of the solar power in the final user load, without cycling energy in the battery(-ies).

If battery(-ies) are lower than the priority voltage, solar power is used to recharge the battery(-ies). Charging from the grid is now allowed because the objective is to keep the battery(-ies) charged for backup time (generator is off, blackout, no more sun,...).

For proper functioning of the system, the voltage target of the solar/wind regulator should therefore be above the battery(-ies) priority voltage.

Solar priority function's algorithm

The solar priority function's algorithm maintains the battery(-ies) at a proper level for long lifetime and always keeps a reserve of energy for backup.

The input limit is reduced linearly over a working range as shown in the graphic below:

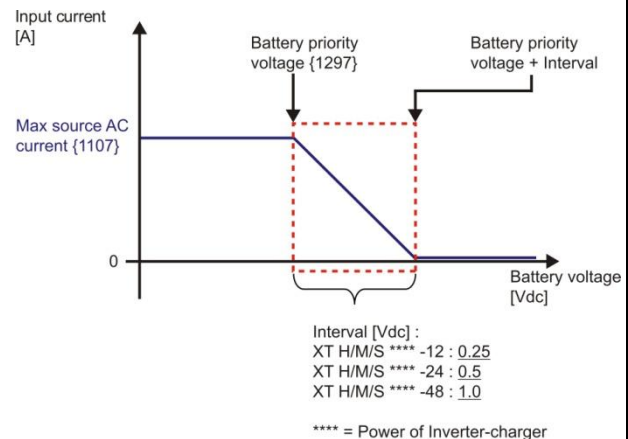

(Figure 4) Graph of Solar priority function. (Current taken on the AC source depending on the battery(-ies))

Parameters

Four parametersⁱⁱⁱ allow controlling the energy management with different sources:

1. "Battery(-ies) priority as energy source" {1296}
2. "Smart-Boost allowed" {1126}
3. "Battery(-ies) priority voltage" {1297}
4. "Maximum current of AC source (Input limit)" {1107}

Notes

Associated application notes :

- ▶ AN001 AC source assistance (Smart Boost function)

- ⁱ More information about the Smart-Boost is available on the "AN001 AC source assistance (Smart-Boost function)"
- ⁱⁱ The voltage values for the battery(-ies) priority voltage {1297} are available at the next page, item : "Battery(-ies) priority voltage"
- ⁱⁱⁱ More information about the source max AC current and the battery(-ies) priority voltage are available at the next page

RCC -02 / -03 programming guide

1. User level to EXPERT

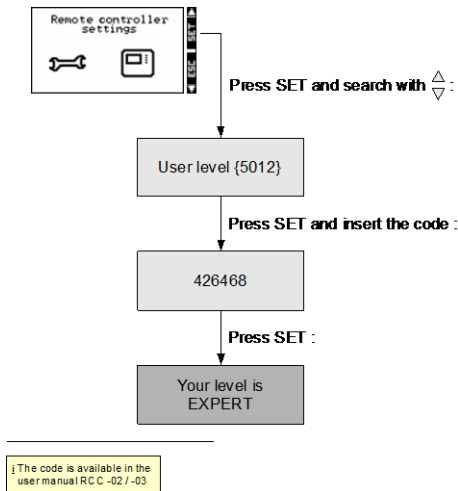

2. Smart-Boost allowed

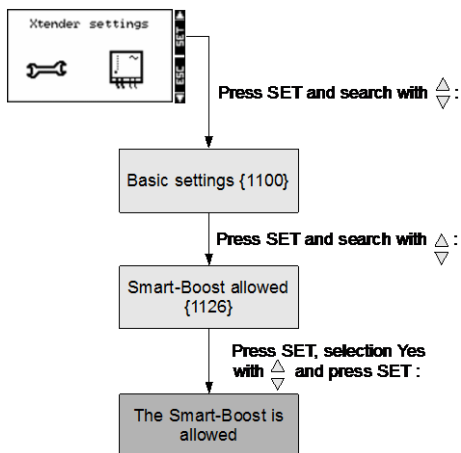

3. Batteries priority as energy source

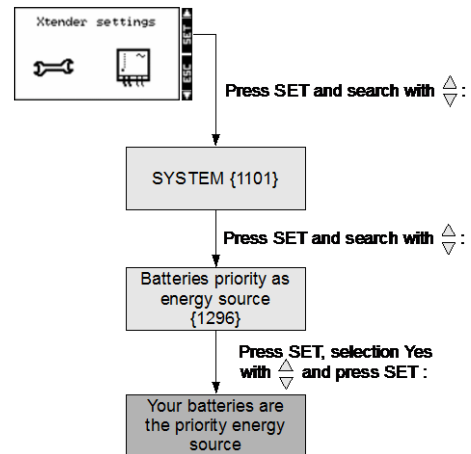

4. Battery priority voltage

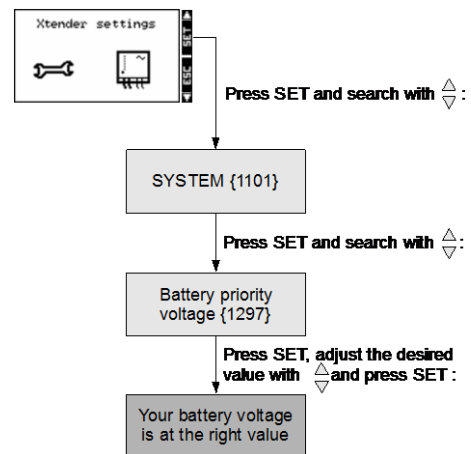

5. Maximum current of AC source (Input limit)

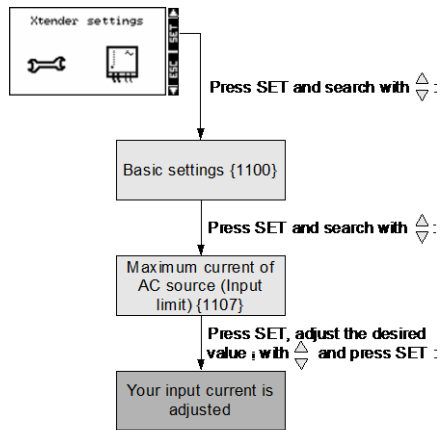

! The current value [Aac] must be set according to the size of the circuit breaker or the grid capacity

